

Item name	PWM5-Pro
Ordering code	PW05
Item code	PWM5-Pro
Date	10-SEPT-2025

## PWM5 Pro - Constant Voltage LED Driver

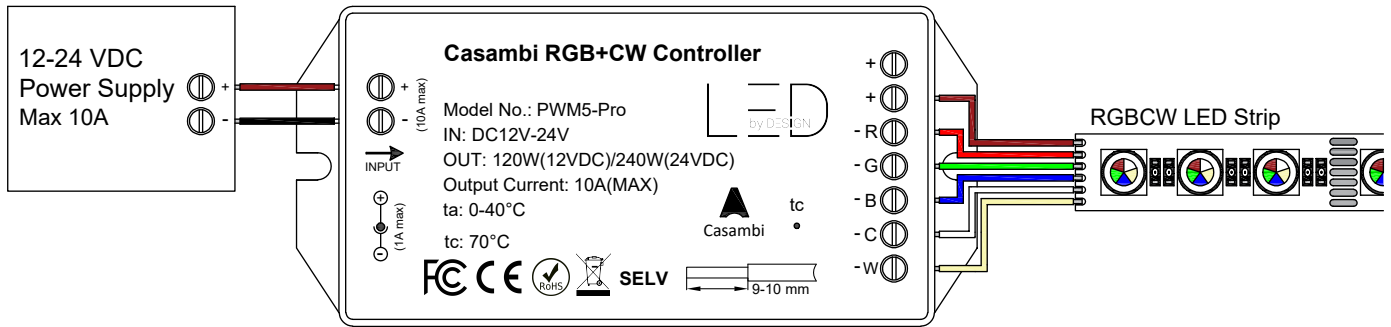

### Description

PWM5 Pro is a 5-channel PWM dimmer designed for controlling constant-voltage LED loads, such as LED strips and modules. It is equipped with Bluetooth connectivity and Casambi-enabled features that allow for easy and convenient control of LED lighting fixtures. The dimmer is installed between a 12-24 VDC power supply and the constant-voltage LED load.

Each channel of the PWM5 Pro is capable of delivering a maximum output current of 4A, and the combined total output current of all channels is 10A max. Additionally, the device is protected against overload and provides flicker-free lighting experience.

### Control

Dimmable by Casambi app which can be downloaded free of charge from Apple App Store and Google Play Store.

### Properties

Input Voltage:	12-24V DC
Max. input current:	10A
Max. output current:	10A (4A/ch)
Output Voltage :	Same as input
Max Output Power:	120W @12VDC / 240W @24VDC
Wire type:	14-22AWG
Device Control:	PWM by Casambi App
Case size:	100 x 47 x h 23 mm
Weight:	51g
Protection:	IP20
Operating temp:	-20 to 50°C
Installation:	Remote
Control options:	Available profiles
1-5 channels	1-5 channels independent-channel
2 channels	CCT Tunable white
3 channels	RGB
4 channels	RGBW
4 channels	RGB+White
5 channels	RGBTW / RGBWA
5 channels	RGB + TW
Certificates:	CE, FCC, LVD(2014/35/EU)**

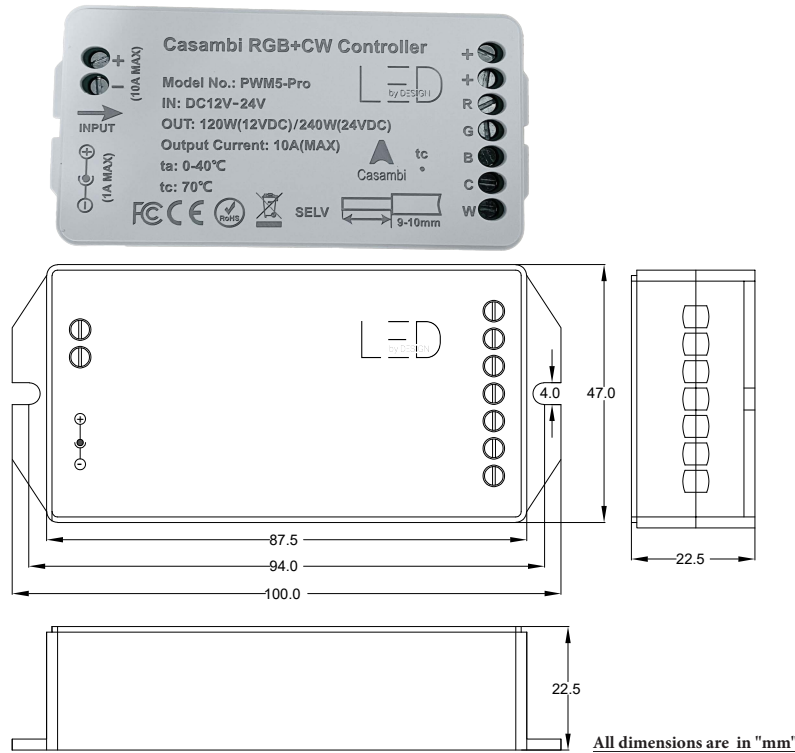

NOTES: \*\*Low Voltage Directive (2014/35/EU): The products applicative voltage is under 75VDC of LVD minimum adopted voltage. For more information and user manual please contact: [sales@ledbydesign.asia](mailto:sales@ledbydesign.asia)

We reserve the right to change specifications without prior notification.

Item name	PWM5-Pro
Ordering code	PW05
Item code	PWM5-Pro
Date	10-SEPT-2025

## Multiple Channel Option Diagrams:

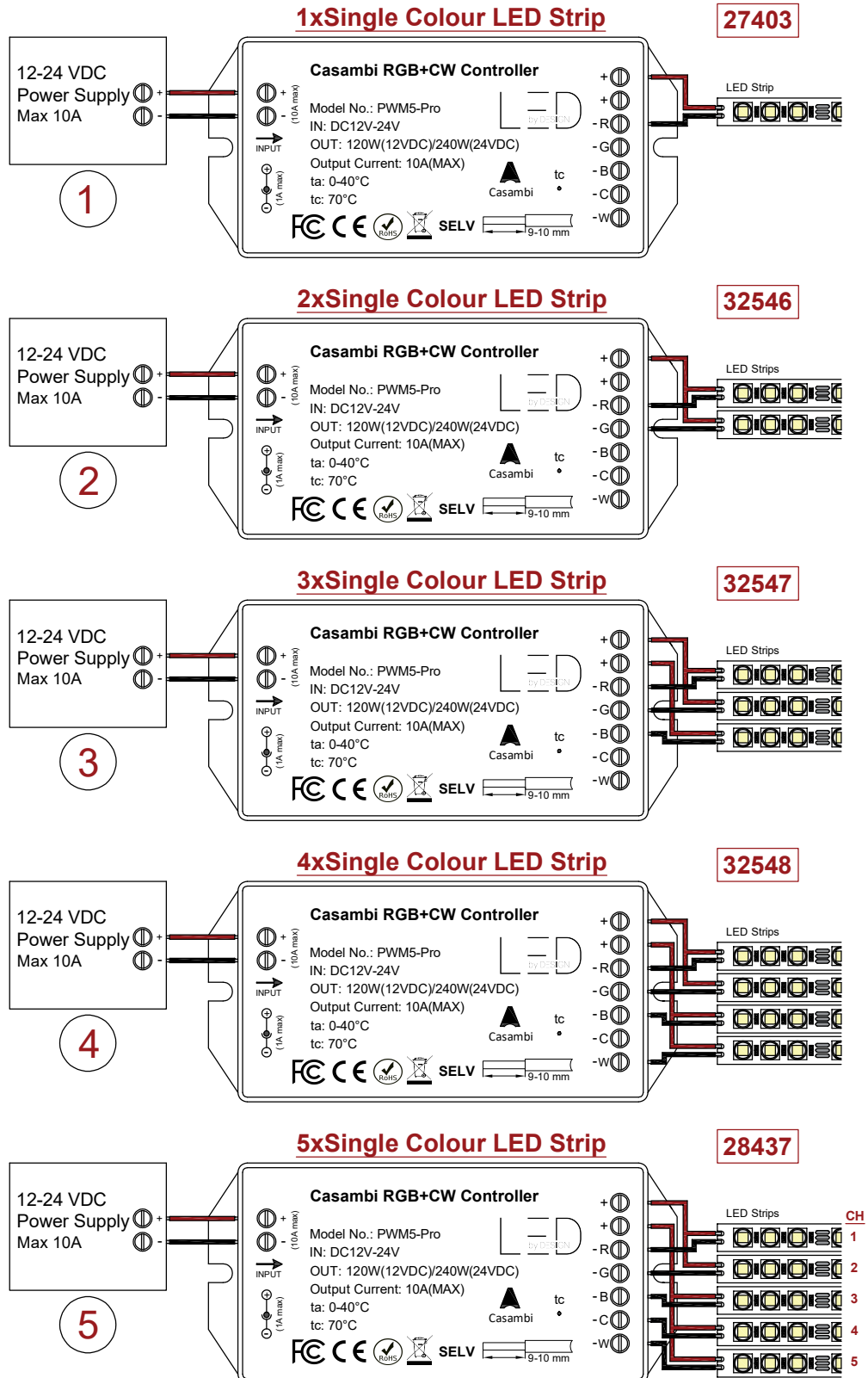

NOTES: \*\*Low Voltage Directive (2014/35/EU): The products applicative voltage is under 75VDC of LVD minimum adopted voltage.  
For more information and user manual please contact: sales@ledbydesign.asia

We reserve the right to change specifications without prior notification.

Item name	PWM5-Pro
Ordering code	PW05
Item code	PWM5-Pro
Date	10-SEPT-2025

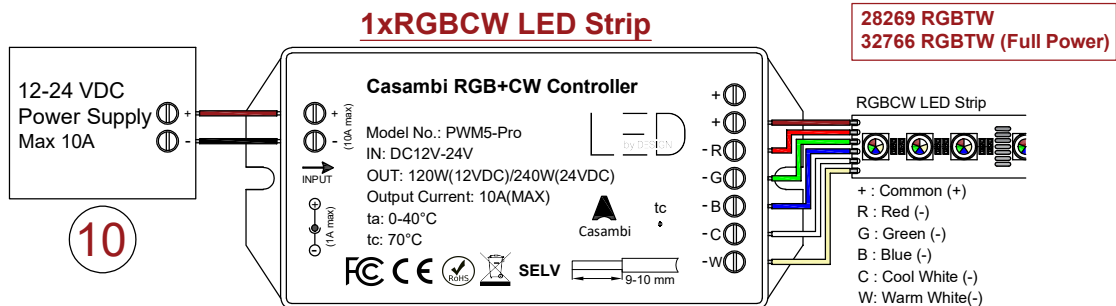
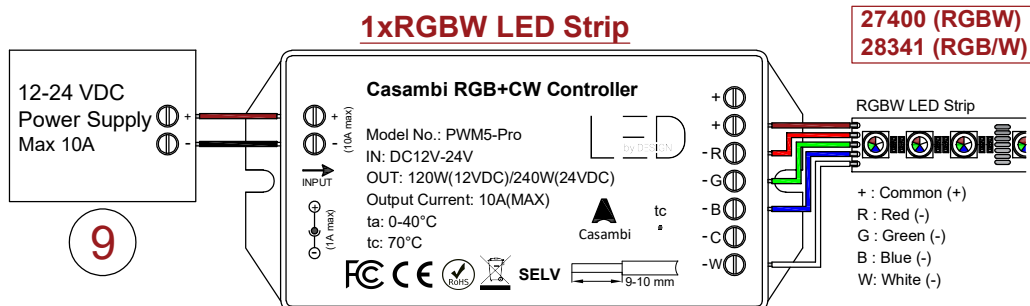
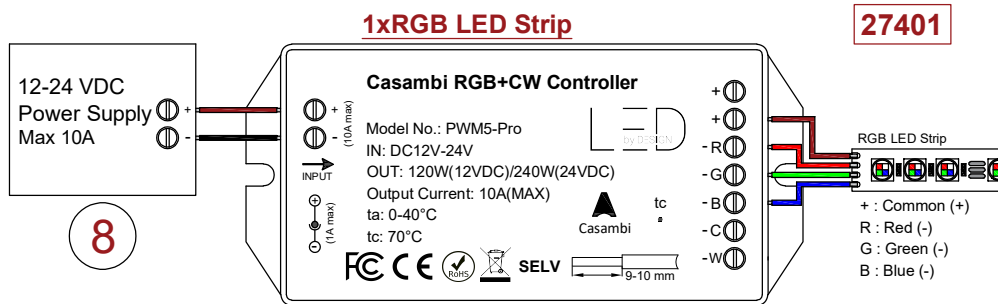
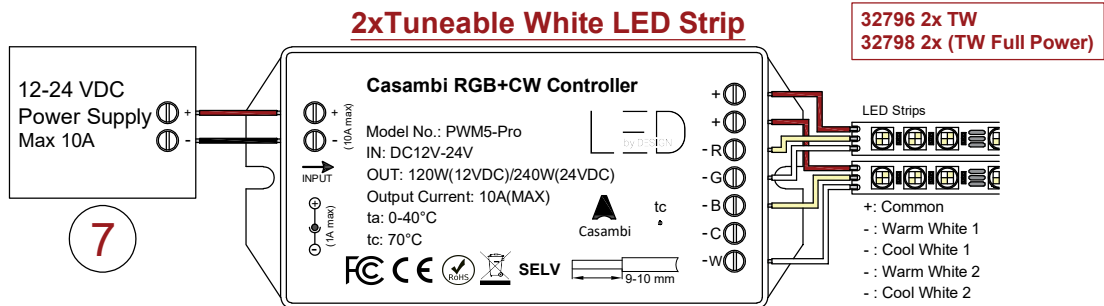
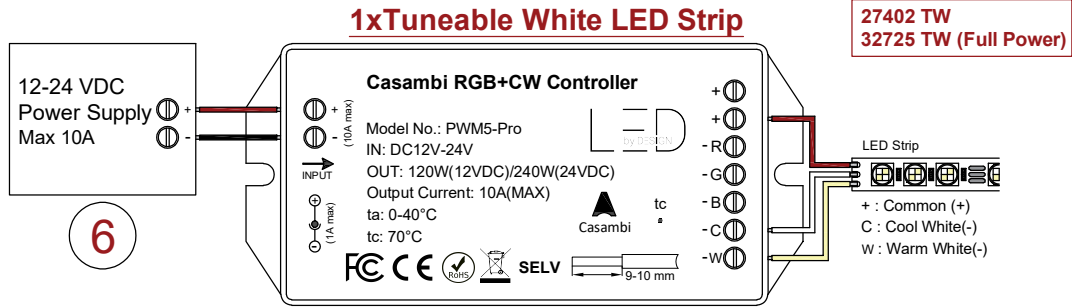

NOTES: \*\*Low Voltage Directive (2014/35/EU): The products applicative voltage is under 75VDC of LVD minimum adopted voltage.  
 For more information and user manual please contact: sales@ledbydesign.asia

We reserve the right to change specifications without prior notification.