

Driver LC 40W 500-1050mA bDW NFC T EXC3 excite NFC in-track series

Product description

- Dimmable constant current / in-track LED driver
- Optional accessory ACU ALU NIPPLE M10x1 for mounting the luminaire head
- Compatible 3P system in-tracks, see data sheet chapter 3.8
- Forms automatically a wireless communication network with up to 250 node
- Dimming range 1 to 100 % (min. 5 mA)
- For luminaires of protection class II
- Temperature protection as per EN 61347-2-13 C5e
- Adjustable output current between 500 and 1,050 mA via near field communication (NFC)
- Max. output power 40 W
- Up to 85 % efficiency
- Power input on stand-by < 0.5 W
- Nominal lifetime up to 100,000 h
- 5 years guarantee (conditions at www.tridonic.com)

Housing properties

- Casing: polycarbonat, black, white or grey
- Type of protection IP20

Interfaces

- basicDIM Wireless
- Near field communication (NFC)

Functions

- Adjustable output current in 1-mA-steps (NFC)
- Overtemperature protection
- Overload protection
- Short-circuit protection
- No-load protection
- Burst protection voltage 2 kV
- Surge protection voltage 1 kV (L to N)

Benefits

- Flexible configuration via companionSUITE (NFC)
- Support NFC multiple programming (full carton box)

Typical applications

- For spot light in retail and hospitality application



Standards, page 4

Wiring diagrams and installation examples, page 4



Black (RAL 9005)



Grey (RAL 7035)



White (RAL 9010)



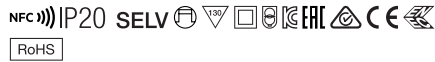

Driver LC 40W 500-1050mA bDW NFC T EXC3 excite NFC in-track series

Technical data

Rated supply voltage	220 – 240 V
AC voltage range	198 – 264 V
Max. input current (at 230 V, 50 Hz, full load)	0.23 A
Mains frequency	50 / 60 Hz
Overvoltage protection	320 V AC, 48 h
Leakage current (at 230 V, 50 Hz, full load)	< 700 µA
Max. input power	49 W
Typ. efficiency (at 230 V / 50 Hz / full load) ^①	85 %
λ (at 230 V, 50 Hz, full load) ^①	0.95
Typ. power consumption (at 230 V, 50 Hz, full load) ^①	46.6 W
Min. output power	0.07 W
Max. output power	40 W
Typ. power consumption on stand-by ^②	< 0.5 W
THD (at 230 V, 50 Hz, full load) ^③	< 10 %
Starting time (at 230 V, 50 Hz, full load)	< 0.66 s
Turn off time (at 230 V, 50 Hz, full load)	≤ 0.03 s
Hold on time at power failure (output)	0 s
Output current tolerance ^④	± 5 %
Max. output current peak ^⑤	≤ output current + 20 %
Output LF current ripple (< 120 Hz)	± 3 %
Output P _{SI} L ^M (at full load)	≤ 1
Output SVM (at full load)	≤ 0.4
Max. output voltage (U-OUT)	60 V
Dimming range	1 – 100 % (min. 5 mA)
Ambient temperature t _a (at lifetime 100,000 h)	25 °C
Storage temperature t _s	-40 ... +80 °C
Mains surge capability (between L - N)	1 kV
Radio transceiver operating frequencies	2.4 – 2.483 GHz
Max. output power radio transceiver (E.I.R.P.) ^⑥	< +20 dBm
Lifetime	up to 100,000 h
Guarantee (conditions at www.tridonic.com)	5 years
Dimensions L x W x H	231 x 42,4 x 32 mm

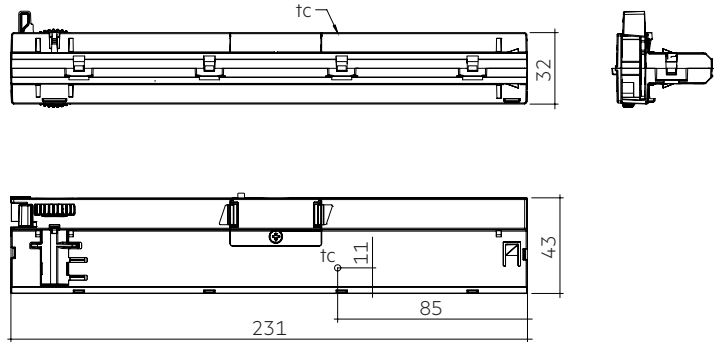

Ordering data

Type	Article number	Colour	Packaging, carton	Packaging, pallet	Weight per pc.
LC 40/500-1050/42 bDW NF T-B EXC3	28003057	Black	10 pc(s).	1,260 pc(s).	0.150 kg
LC 40/500-1050/42 bDW NF T-W EXC3	28003058	White	10 pc(s).	1,260 pc(s).	0.150 kg
LC 40/500-1050/42 bDW NF T-G EXC3	28003059	Grey	10 pc(s).	1,260 pc(s).	0.148 kg

Specific technical data

Type	Output current ^②	Min. forward voltage ^④	Max. forward voltage	Max. output power	Typ. power consumption (at 230 V, 50 Hz, full load)	Typ. current consumption (at 230 V, 50 Hz, full load)	Max. casing temperature t _c	Ambient temperature t _a max.
LC 40/500-1050/42 bDW NF T EXC3	500 mA	14,0 V	42,0 V	21,0 W	25,0 W	99 mA	80 °C	-20 ... +35 °C
	600 mA	14,0 V	42,0 V	25,2 W	30,0 W	117 mA	80 °C	-20 ... +35 °C
	700 mA	14,0 V	42,0 V	29,4 W	34,6 W	134 mA	80 °C	-20 ... +35 °C
	800 mA	14,0 V	42,0 V	33,6 W	38,9 W	150 mA	80 °C	-20 ... +35 °C
	900 mA	14,0 V	42,0 V	37,8 W	43,5 W	167 mA	80 °C	-20 ... +35 °C
	1,050 mA	14,0 V	38,1 V	40,0 W	46,6 W	179 mA	80 °C	-20 ... +35 °C

^① Test result at 1,050 mA.

^② Output current is mean value.

^③ Test result at 25 °C.

^④ Device operates down to 4 V output voltage. It cannot be guaranteed that harmonics and EMI stay inside the limits. This has to be checked individually.

^⑤ Depending on the basicDIM Wireless traffic.

^⑥ E.I.R.P.: Equivalent Isotropically Radiated Power.

Product description

- Optional threaded sleeve for luminaire mounting
- Suitable for S-9009/D-M10 threaded nut
- Additional mounting equipment, e.g. M8x1 or M13x1 available at AAG Stucchi (<http://www.aagstucchi.it/en/>)

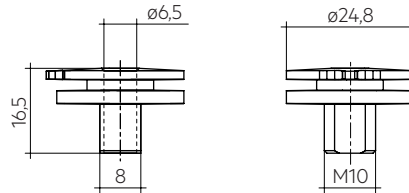

Ordering data

Type	Article number	Packaging, bag	Weight per pc.
ACU ALU NIPPLE M10x1	28002398	100 pc(s).	0.007 kg

1. Standards

EN 55015
EN 61000-3-2
EN 61000-3-3
EN 61000-4-4
EN 61000-4-5
EN 61347-1
EN 61347-2-13
EN 61547
EN 62384
EN 62386
ETSI EN 300 330
ETSI EN 301 489-1
ETSI EN 301 489-3
ETSI EN 300 328
ETSI EN 301 489-17

1.1 Glow-wire test

according to EN 61347-1 with increased temperature of 850 °C passed (Grey RAL 7035 / White RAL 9010).
according to EN 61347-1 with increased temperature of 750 °C passed (Black RAL 9005).

2. Thermal details and lifetime

2.1 Expected lifetime

Expected lifetime

Type	ta	25 °C	35 °C
LC 40/500-1050/42 bDW NF T EXC3	Lifetime	100,000 h	50,000 h

^① Test result at max. output voltage.

The LED drivers are designed for a lifetime stated above under reference conditions and with a failure probability of less than 10 %.

3. Installation / wiring

3.1 Circuit diagram

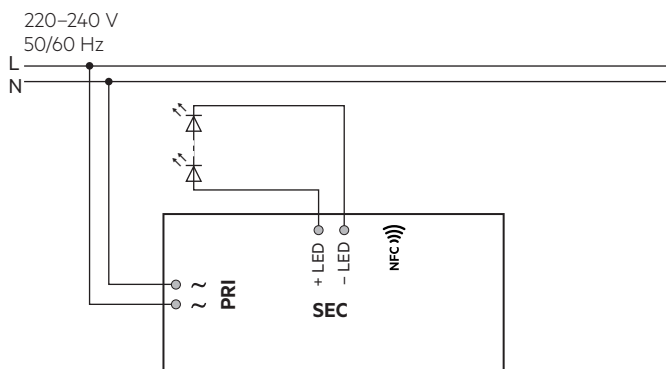

3.2 Wiring type and cross section

The wiring can be in stranded wires with ferrules or solid with a cross section of 0.2–0.5 mm². Strip 8.5–9.5 mm of insulation from the cables to ensure perfect operation of the push-wire terminals. Use one wire for each terminal connector only.

wire preparation:
0.2 – 0.5 mm²

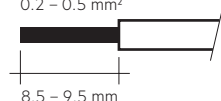

3.3 Release of the wiring

Press down the “push button” and remove the cable from front.

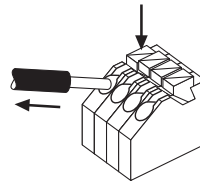

3.4 Fixing conditions

Dry, acidfree, oilfree, fatfree. It is not allowed to exceed the maximum ambient temperature (ta) stated on the device.

3.5 Wiring guidelines

- All connections must be kept as short as possible to ensure good EMI behaviour.
- Max. length of output wires is 20 cm.
- Secondary switching is not permitted.
- Incorrect wiring can damage LED modules.
- To avoid the damage of the Driver, the wiring must be protected against short circuits to earth (sharp edged metal parts, metal cable clips, louver, etc.).

3.6 Replace LED module

1. Mains off
2. Remove LED module
3. Wait for 10 seconds
4. Connect LED module again

Hot plug-in or secondary switching of LEDs is not permitted and may cause a very high current to the LEDs.

3.7 Mounting luminaire

Max. allowed weight of complete luminaire: 5 kg (50 N).
This is valid for horizontal mounting of track system only.
For vertical installation please contact Tridonic for clarification.

3.8 Compatible tracks

Subject to be changed without notice.

Manufacturer	Type	System	Intrack casing colour
EUTRAC	25-XX-XX / 26-XX-XX	3P	Black, white, grey
iGuzzini	6771-6774	3P	Black, white, grey
iGuzzini	6779-6782	3P	Black, white, grey
IVELA	7501 / 7511 / 7512	3P	Black, white, grey
LUMISYS UNIPRO	T32 / T33 /34	3P	Black, white, grey
LUMISYS UNIPRO	T32F / T33F /34F	3P	Black, white, grey
NORDIC ALUMINIUM	GLOBAL Trac Pro XTS 4xxx	3P	Black, white, grey
NORDIC ALUMINIUM	GLOBAL Trac Pro XTSF 4xxx	3P	Black, white, grey
ZUMTOBEL	S280...	3P	Black, white, grey
ERCO	783...	3P	Black, white, grey
SIDE	25101	3P	Black, white, grey
PHILIPS	RCS350 3C	3P	Black, white, grey
FOSNOVA	OMNITRACK	3P	Black, white, grey
Stucchi	ONETRACK	3P	Black, white, grey
Powergear	PRO-0610	3P	Black, white, grey
Unipro	T32W	3P	Black, white, grey
Unipro	T32FW	3P	Black, white, grey

Tests have been done with in-tracks taken from the market in the first half of 2020.



Tridonic has no control or responsibility on any future or past possible changes made by different manufactures that could affect the compatibility between tracks and adapters.

3.9 Insulation between terminals

Insulation	Mains	-LED / +LED
Mains	-	double
-LED / +LED	double	-

basic ... represents basic insulation.
double ... represents double or reinforced insulation.

3.11 Phase selection

When the track is connected to a three-phase system it is possible to select the phase (L1, L2 or L3) to distribute the single luminaires in the system, by means of the proper selector (A) of the adaptor.

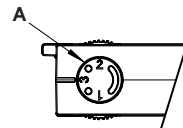

3.10 Adapter mounting into the track

Insert the adapter into the track, so that the mechanical key (A) in the adaptor matches the groove (B) in the track. Rotate of about 90° the lever of the cam (C) until it reaches the locking position.
To open rotate the lever the opposite direction.

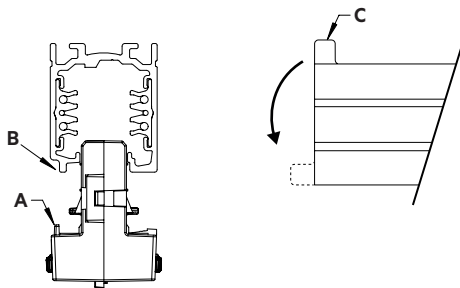

4. Electrical values

4.1 Operating window

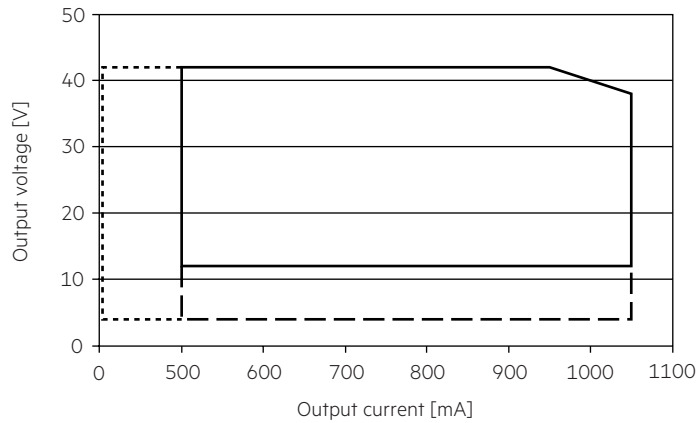

- Operating window
- Operating window dimmed
- - - Operating window 4 V

Device operates down to 4 V output voltage. It cannot be guaranteed that harmonics and EMI stay inside the limits. This has to be checked individually.

4.2 Efficiency vs load

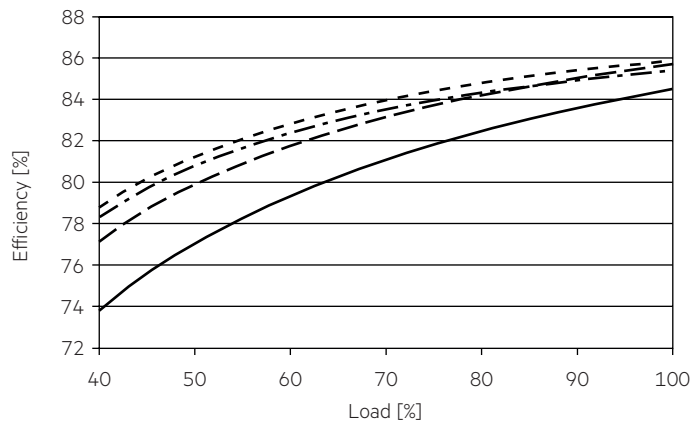

4.3 Power factor vs load

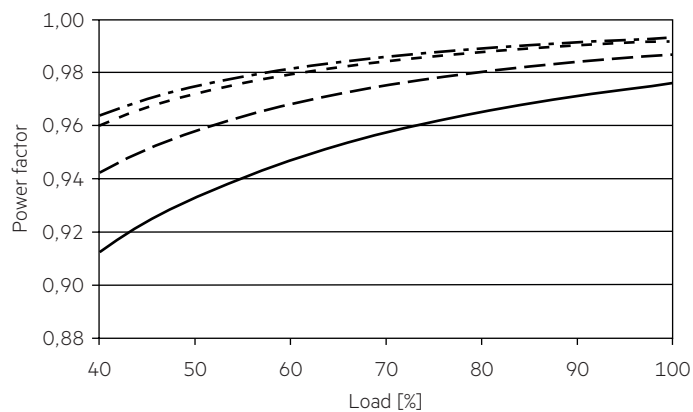

4.4 Input power vs load

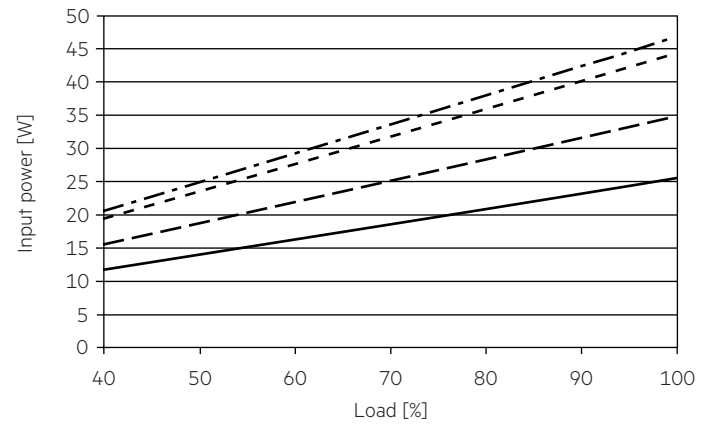

4.5 Input current vs load

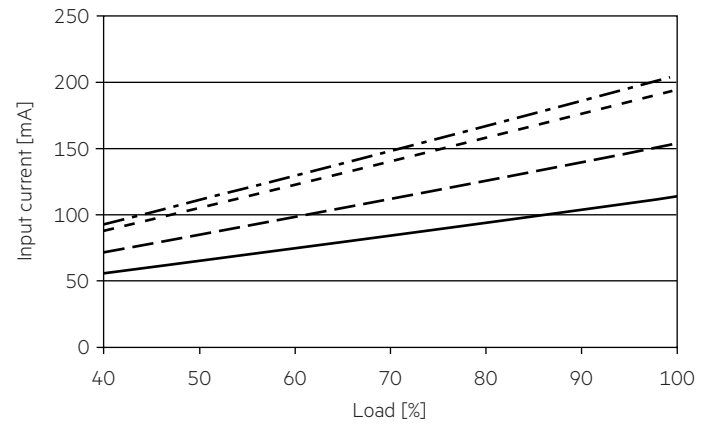

4.6 THD vs load

THD without harmonic < 5 mA (0.6 %) of the input current:

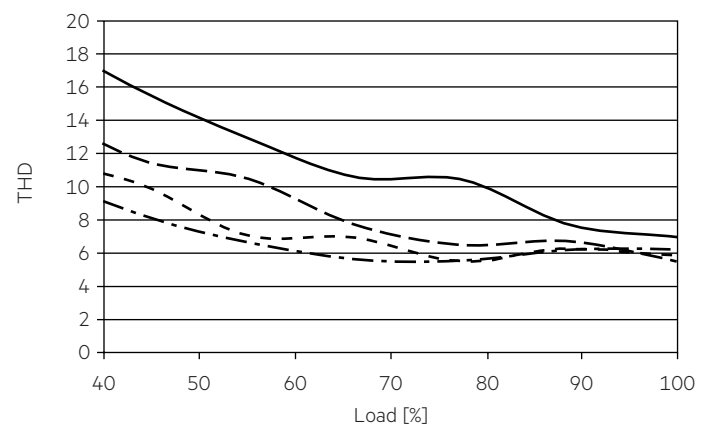

- 500 mA
- - - 700 mA
- · - 900 mA
- 1050 mA

4.7 Maximum loading of automatic circuit breakers in relation to inrush current

Automatic circuit breaker type	C10	C13	C16	C20	B10	B13	B16	B20	Inrush current	
Installation Ø	15 mm ²	15 mm ²	15 mm ²	2.5 mm ²	15 mm ²	15 mm ²	15 mm ²	2.5 mm ²	I _{max}	Time
LC 40/500-1050/42 bDW NF T EXC3	40	52	64	80	40	52	64	80	9.6 A	32 µs

These are max. values calculated out of inrush current! Please consider not to exceed the maximum rated continuous current of the circuit breaker.

Calculation uses typical values from ABB series S200 as a reference.

Actual values may differ due to used circuit breaker types and installation environment.

4.8 Harmonic distortion in the mains supply (at 230 V / 50 Hz and full load) in %

	THD	3.	5.	7.	9.	11.
LC 40/500-1050/42 bDW NF T EXC3	< 11	< 9	< 3	< 3	< 4	< 3

Acc. to 6100-3-2. Harmonics < 5 mA or < 0.6 % (whatever is greater) of the input current are not considered for calculation of THD.

4.9 Dimming characteristics

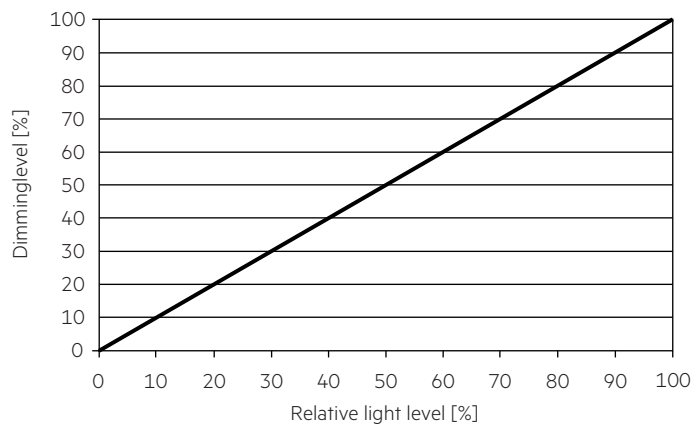

5. Software / Programming / Interfaces

5.1 Software / programming

With appropriate software and interface different functions can be activated and various parameters can be configured in the LED driver. The Driver supports the following software and interfaces:

Software / hardware for configuration:

- companionSUITE (deviceGENERATOR, deviceCONFIGURATOR, deviceANALYSER)

Interfaces for data transfer:

- NFC

5.2 Nearfield communication (NFC)

The NFC Interface allows wireless communication with the LED driver.

This interface offers the option to write configuration and to read configuration, errors and events with the companionSUITE.

A correct communication between the LED driver and the NFC antenna can only be guaranteed if the Driver is directly placed on the antenna.

Any material placed between the LED driver and the NFC antenna can cause a deterioration of the communication quality.

We recommend the use of following NFC antennas:

www.tridonic.com/nfc-readers





NFC is compliant with ISO/IEC 15963 standard.

6. Functions

☉ companionSUITE:

NFC

The companionSUITE with deviceGENERATOR, deviceCONFIGURATOR and deviceANALYSER is available via our WEB page:
<https://www.tridonic.com/com/en/products/companionsuite.asp>

Icon	Function	NFC
	OEM Identification	☉
	OEM GTIN	☉
	LED current	☉
	corridorFUNCTION	☉
	Constant light output (CLO)	☉

6.1 LED current



The LED output current must be adapted to the connected LED module.
The value is limited by the current range of the respective device.

6.2 Constant Light Output (CLO)



With this function the light output of the LED module can be kept equal over the lifetime.

The light output of an LED module reduces over the course of its lifetime.

The Constant Light Output (CLO) function compensates for this natural decline by constantly increasing the output current of the LED driver throughout its lifetime.

CLO shall be achieved by limitation of the LED current at the commissioning of the LED driver and providing a linear interpolation of the current over the time, depending on the data points given by the user.

The user has to insert up to eight pairs of data (time, level).

The output curve is the result of connecting the user data points linear.

Detailed description for CLO see product manual.

7. Protective features

7.1 Short-circuit behaviour

In case of a short circuit on the secondary side (LED) the LED driver switches off. After elimination of the short-circuit fault the LED driver will recover automatically.

7.2 No-load operation

The LED driver works in burst working mode to provide a constant output voltage regulation which allows the application to be able to work safely when LED string opens due to a failure.

7.3 Overload protection

If the maximum load is exceeded by a defined internal limit, the LED driver will protect itself and LED may flicker. After elimination of the overload the nominal operation will recover automatically.

7.4 Overtemperature protection

The LED driver is protected against temporary thermal overheating. If the temperature limit is exceeded the LED driver will switch off. It restarts automatically. The temperature protection is activated above t_c max.

8. Miscellaneous

8.1 Insulation and electric strength testing of luminaires

Electronic devices can be damaged by high voltage. This has to be considered during the routine testing of the luminaires in production.

According to IEC 60598-1 Annex Q (informative only!) or ENEC 303-Annex A, each luminaire should be submitted to an insulation test with 500 V_{DC} for 1 second. This test voltage should be connected between the interconnected phase and neutral terminals and the earth terminal. The insulation resistance must be at least 2 MΩ.

As an alternative, IEC 60598-1 Annex Q describes a test of the electrical strength with 1500 V_{AC} (or 1.414 × 1500 V_{DC}). To avoid damage to the electronic devices this test must not be conducted.

The equipotential terminal is used to connect the heat sink and the LED driver to reduce transients.

8.2 Conditions of use and storage

Humidity: 5 % up to max. 85 %,
not condensed
(max. 56 days/year at 85 %)

Storage temperature: -40 °C up to max. +80 °C

The devices have to be acclimatised to the specified temperature range (t_a) before they can be operated.

8.3 Placement

basicDIM Wireless has an integrated antenna for easy integration. In order to maximize the range in every direction some design guidelines should be taken into consideration when mounting the device.

The antenna is located on the housing side not covered by the track. The device should be placed as far away from any vertical metal structures as possible.

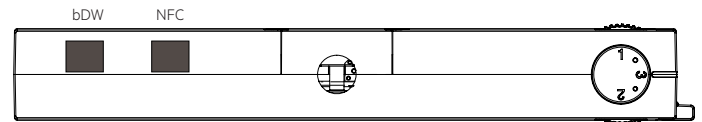

The range of the communication signal is depending on the environment e.g. luminaire, construction of the building, furnitures or humans and needs to be tested and approved in the installation.

8.4 Network compatibility

This Driver is fully compatible with networks which support up to 250 nodes (Evolution networks). If the Driver is used with different types of basicDIM Wireless devices in an Evolution network, their compatibility has to be checked before. If a device is not compatible with Evolution networks, it can be only used in networks which support up to max. of 127 devices (Classic networks).

8.5 Maximum number of switching cycles

All LED driver are tested with 50,000 switching cycles. The actually achieved number of switching cycles is significantly higher.

8.6 Additional information

Additional technical information at www.tridonic.com → Technical Data

Lifetime declarations are informative and represent no warranty claim. No warranty if device was opened.