

Casambi blind actuator

CBA UP Item.No.: 10.752

NEW

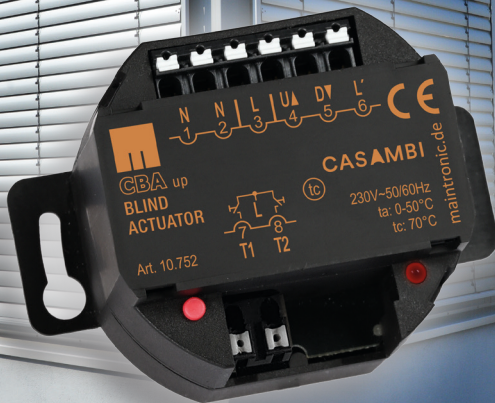

- Casambi actuator for blinds ...
- Absolute horizontal positioning
- Slat angle control (on blinds)
- Two programmable inputs
- Easy to calibrate

Casambi blind actuator for roller blinds / blinds / awnings. Automate your environment with Casambi ready sensors. With your tablet or smartphone controlling and configuration such as control time functions is very convenient and easy. Safe operation, forget sticking relays thanks to built-in mutual locking.

Enabled with 2 programmable inputs, local control is so much easier. These inputs can be used as a direct pre-configured Up-Down pushbutton or control any casambi enabled device over Casambi input control. It's just a change of a parameter in the app.



Astro functions (Sunrise, Sunset)



Scheduler and Scenes



Collective actions (Grouping)



Pushbutton inputs for local control



Remote push-button control (Easyfit or XPress)

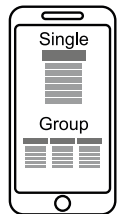

Casambi App automatically identifies the device and can be integrated into existing networks. All functions triggered by the buttons are individually configurable.

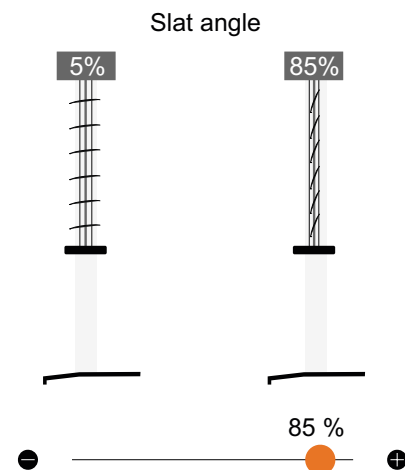
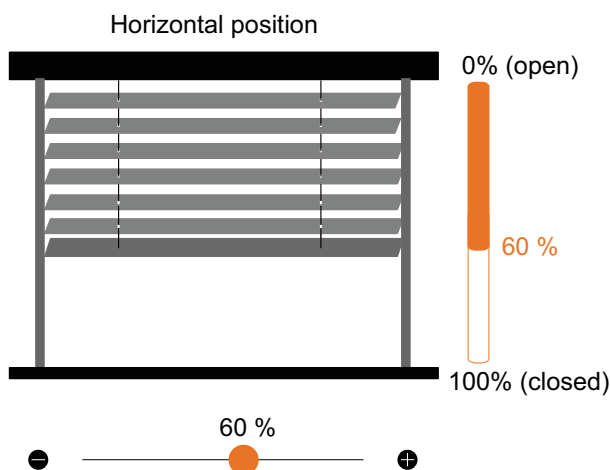

Casambi blind actuator UP

CBA UP Item.No.: 10.752



Specifications

Power supply		100V ... 240V AC 50/60 Hz
Power consumption	watts (on idle / switching)	0.22W / 0.77W
Switching type		16A interlocked changeover
Fuse protection		max 10A
Terminals and Wiring	push-in spring connectors	fine/ single-wire: 0,5 ... 1,5 mm ² (AWG20 ... AWG16) fine-wire with ferrule: 0,5 ... 0,75 mm ² 9 mm (+/- 0,5 mm)
Striping length		
Controls and indicators		DeviceButton, Status-LED
Protocol	Casambi	App available for Android and Apple
Push-button-inputs	2 Inputs on mains voltage	2m cable length max. (on interference free environment)
Environment	Type of protection	IP20
	Protection class	Class II
	Temperature ambient ta	0° to 50° Celsius
	Temperature critical tc	+70° Celsius
	Humidity	5 ... 80% non-condensing (n.c.)
Applied standards	CE	DIN EN 60669-2-1 ETSI EN 301 489-1 v1.9.2 ETSI EN 301 489-17 v2.2.1 ETSI EN 300 328 v1.8.1
Design	Construction	Flush mouted housing
	Installation	flush-mounted or junction box
	Dimensions (height x width x depth) mm	46,5 x 70(51) x 30 (flaps can be removed)
	Ceiling installation	Ø 55mm
	Weight	70g
	Housing	plastics, black
Customs	HS-Code/ TARIC-Number	85365080

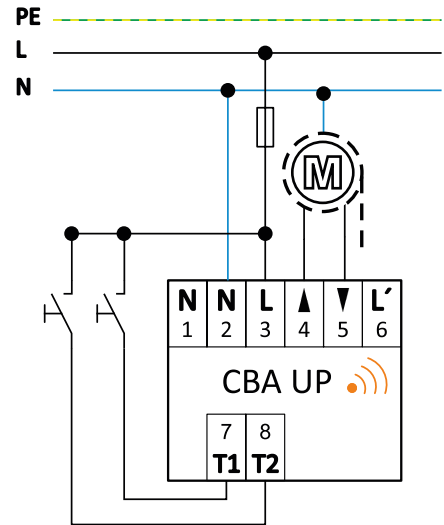

Connection diagram

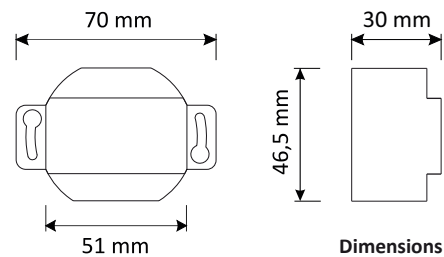

Dimensions

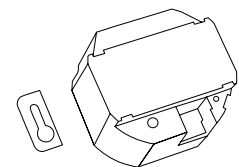

Removeable flaps

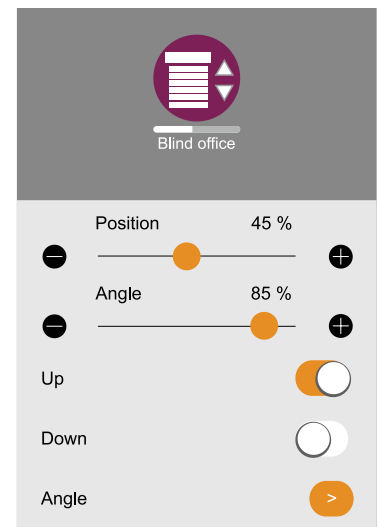

Screenshot APP
fixture
CBA Blind +Button



Easy commissioning and control
by Casambi App



Carl-Zeiss-Str. 10-14
97424 Schweinfurt / Germany

Tel. +49(0)9721-7766 0
Fax. +49(0)9721-7766 18

www.maintronic.de
info@maintronic.de

Valid from version: H2 - Document: 10752_TD_en_A4_CBAUP_20210311